



2
0
2
0

TACTILE
INDICATORS
CATALOGUE



WE OFFER



TACTILE SOLUTIONS
FOR THE BLIND AND
VISUALLY IMPAIRED



ANTI-SLIP
AND NAVIGATION
SOLUTIONS



TACTILE GUIDING SYSTEM



WARNING STUDS

Individual floor tactile warning studs in the shape of a dome or a truncated cone are used to create warning fields. These alert the blind and partially sighted to a change of direction or to an immediate obstacle - a door, stairs, elevator, escalator or pedestrian crossing. They are recognizable by feet, a white cane and also visually. They are made of first-class materials such as stainless steel, brass, bronze, aluminum, ceramic and polyurethane.

AISLINE



MSLINE



ALLINE



BRLINE



TPULINE

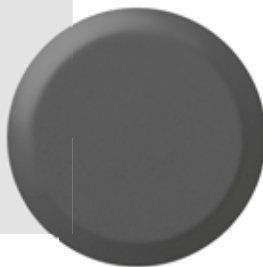

TPUPLINE

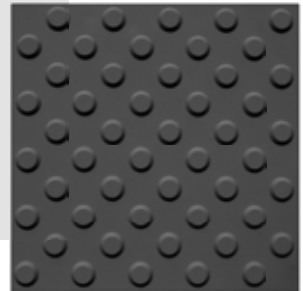



GUIDINGSTRIPS

The individual surface tactile guide strips in the shape of a longitudinal rib are designed in such a way that their functional arrangement on the ground determines guiding instructions and direction of walking for blind and partially sighted people. Guiding lines enable a steady walking pace and are recognizable by feet, a white cane and also visually.

They are made of first-class materials such as stainless steel, brass, bronze, aluminum, ceramic and polyurethane.



AISLINE



MSLINE



ALLINE



BRLINE



TPULINE



TPULINE

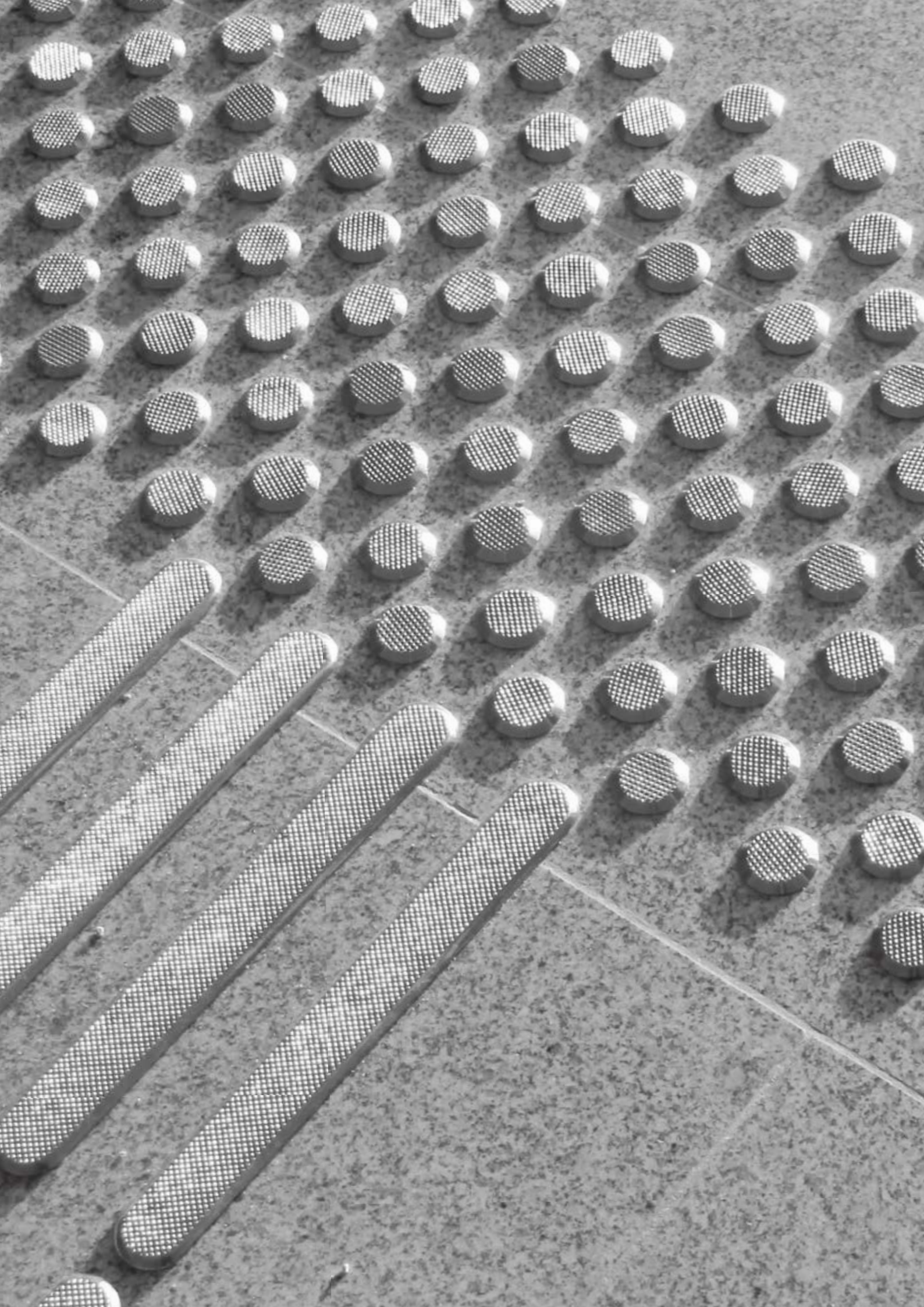



WARNINGSTUDS



WARNINGSTUDS

 DIAMETER 15/25/30/35/50mm

 HEIGHT 1,5/3/3,5/4/4,5/5mm

KH

AISI stainless steel 316L/303

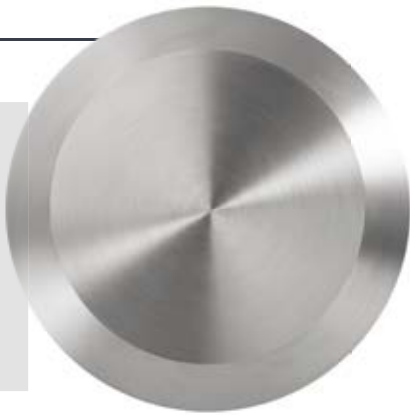

MSbrass



BRbronze



ALaluminium

K1

AISI stainless steel 316L/303



MSbrass



BRbronze



ALaluminium

MODELS



With pin



No pin



Self-adhesive

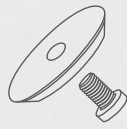

Screw opening

SURFACE TREATMENT

Standard

Polished

Black PVD

Gold PVD

Sandblasted



State Theater
Darmstadt, Germany

KH0



AISI stainless steel 316L/303



MSbrass



BRbronze



ALaluminium

K10



AISI stainless steel 316L/303



MSbrass



BRbronze



ALaluminium



WARNINGSTUDS

 DIAMETER 15/25/30/35/50mm

 HEIGHT 1,5/3/3,5/4/4,5/5mm

K2

AISIstainless
steel 316L/303



MSbrass



BRbronze



ALaluminium

KD

AISIstainless
steel 316L/303

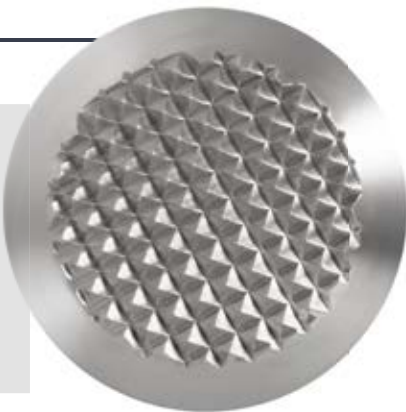

MSbrass



BRbronze



ALaluminium

MODELS



With pin



No pin



Self-adhesive



Screw opening

SURFACE TREATMENT

Standard

Polished

Black PVD

Gold PVD

Sandblasted



Parliament of Lower Saxony
Hannover, Germany

KD3

AISI stainless
steel 316L/303

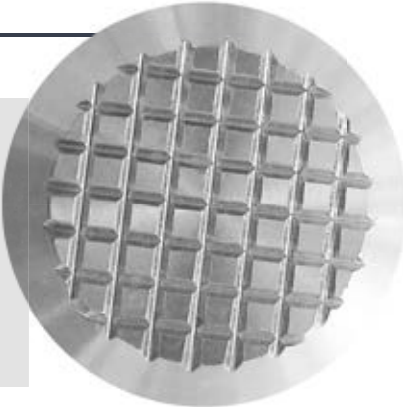

MSbrass



BRbronze



ALaluminium



WARNINGSTUDS

↕ DIAMETER 15/25/30/35/50mm

↕ HEIGHT 1,5/3/3,5/4/4,5/5mm

K1R

AISI stainless steel 316L/303



MSbrass



BRbronze



ALaluminium

KHR

AISI stainless steel 316L/303



MSbrass



BRbronze



ALaluminium

MODELS



With pin



No pin



Self-adhesive



Screw opening

SURFACE TREATMENT

- Standard
- Polished
- Black PVD
- Gold PVD
- Sandblasted



District Office
Siegburg, Germany

KDR

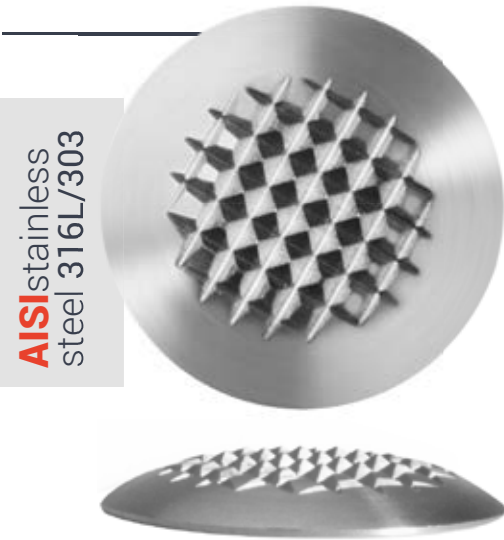

AISI stainless
steel 316L/303



MSbrass



BRbronze

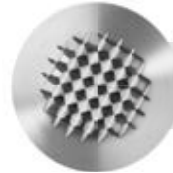

ALaluminium

KHV



AISI stainless
steel 316L/303



MSbrass



BRbronze



ALaluminium



WARNINGSTUDS

↕ DIAMETER 15/25/30/35/50mm

↕ HEIGHT 1,5/3/3,5/4/4,5/5mm

UKD1

AISI stainless steel 316L/303

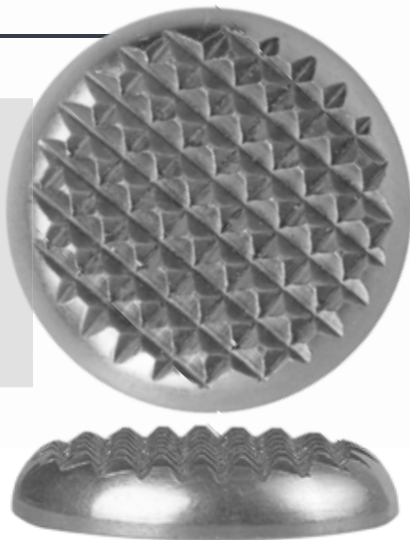

MSbrass



BRbronze

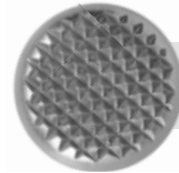

ALaluminium

UKD3

AISI stainless steel 316L/303

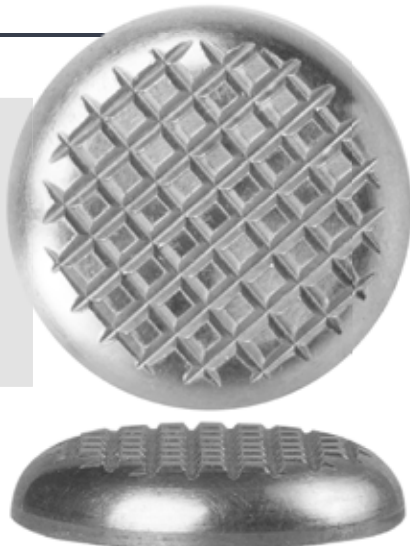

MSbrass



BRbronze

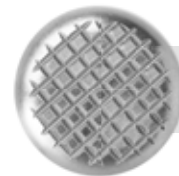

ALaluminium

MODELS



With pin



No pin



Self-adhesive

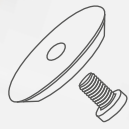

Screw opening

SURFACE TREATMENT

Standard

Polished

Black PVD

Gold PVD

Sandblasted

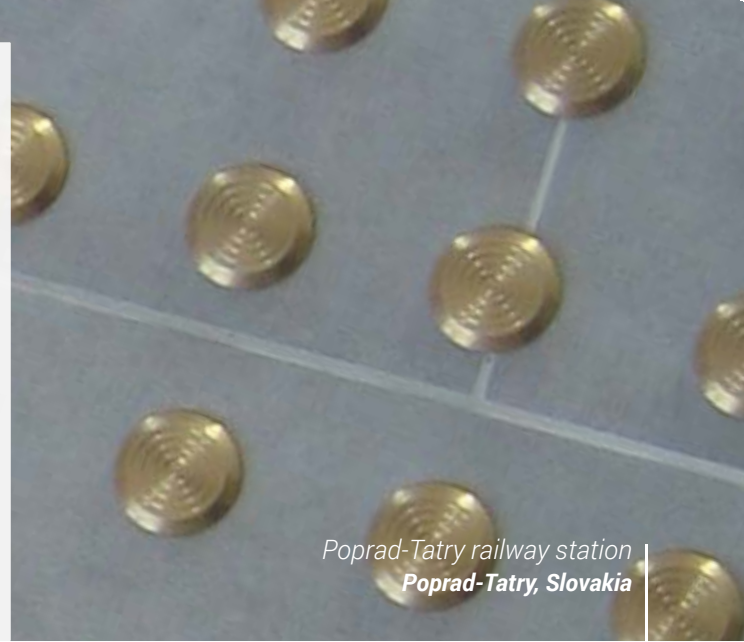

Poprad-Tatry railway station
Poprad-Tatry, Slovakia

UK4

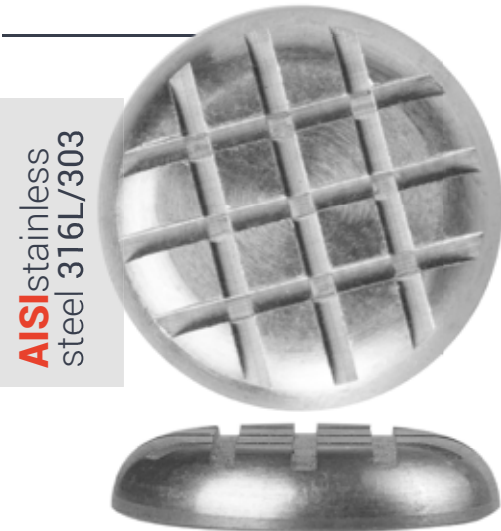

AISI stainless
steel 316L/303



MSbrass



BRbronze



ALaluminium

UKH

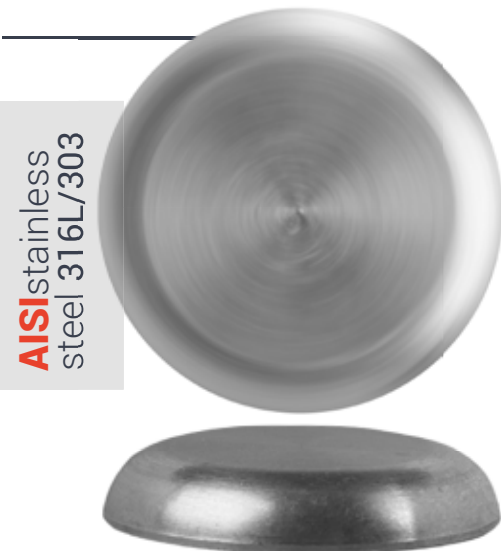

AISI stainless
steel 316L/303



MSbrass



BRbronze



ALaluminium



WARNINGSTUDS

↕ DIAMETER 15/25/30/35/50mm

↕ HEIGHT 1,5/3/3,5/4/4,5/5mm

KP

AISI stainless steel 316L/303

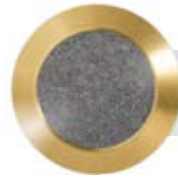
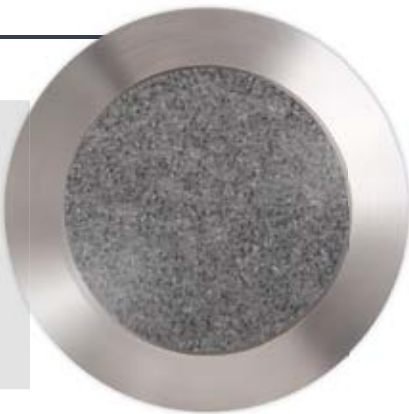

MSbrass

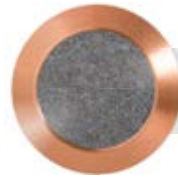

BRbronze



ALaluminium



KTPU

AISI stainless steel 316L/303

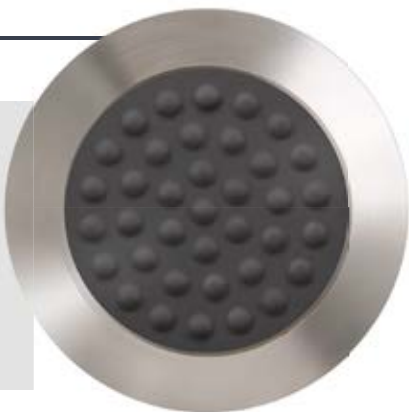

MSbrass



BRbronze



ALaluminium



MODELS



With pin



No pin



Self-adhesive

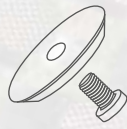

Screw opening

SURFACE TREATMENT

- Standard
- Polished
- Black PVD
- Gold PVD
- Sandblasted



Senica railway station
Senica, Slovakia

KPVC

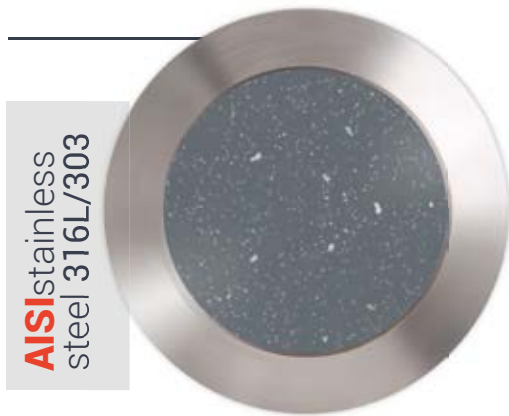

AISI stainless steel 316L/303

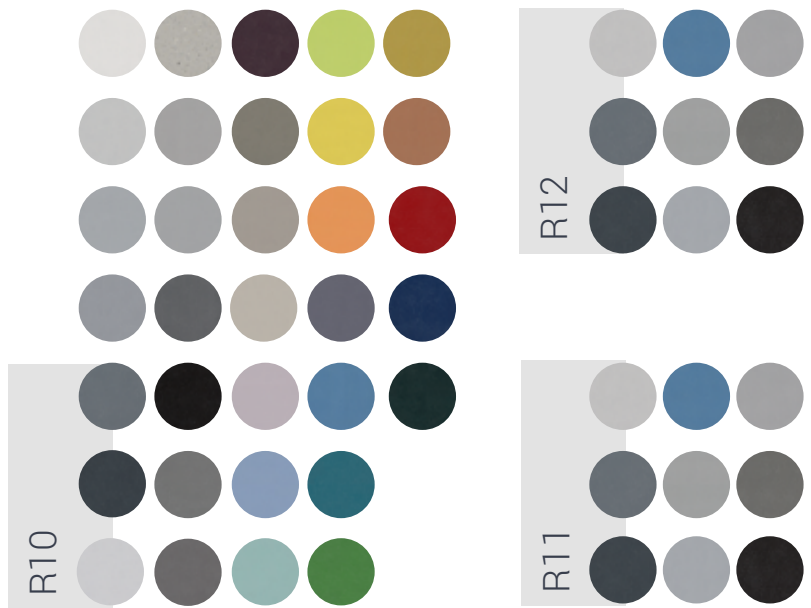

MS brass



BR bronze



AL aluminium



WARNINGSTUDS

 DIAMETER 15/25/30/35/50mm

 HEIGHT 1,5/3/3,5/4/4,5/5mm

TPUK1

TPU polyurethane

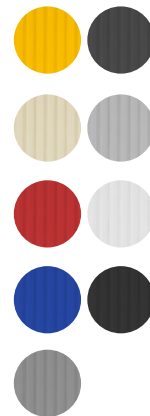
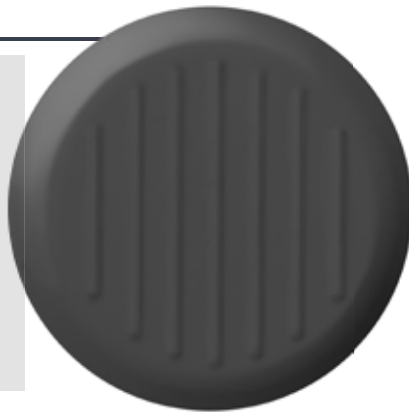

TPUK2

TPU polyurethane



MODELS



With pin



No pin



Self-adhesive

Canadian Museum of Human Rights
Winnipeg, Canada

TPUK3

TPU polyurethane

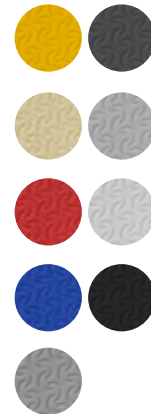

TPUK4

TPU polyurethane

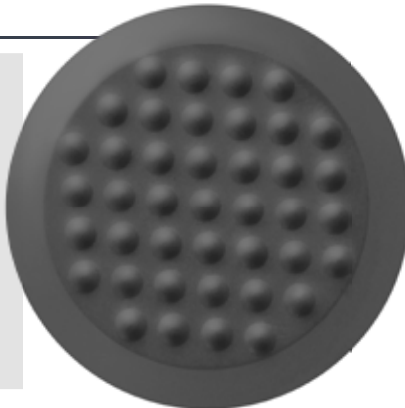



MODELS



With pin



No pin



Self-adhesive



DIAMETER 15/25/30/35/50mm



HEIGHT 1,5/3/3,5/4/4,5/5mm

TPUKH

TPU polyurethane

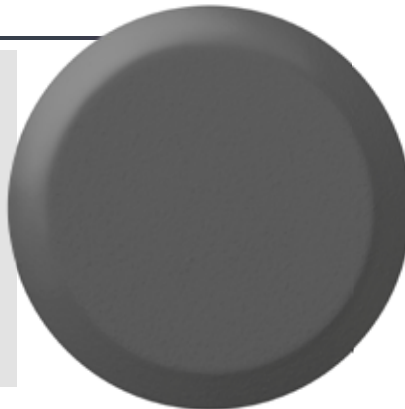

TPUKHR

TPU polyurethane

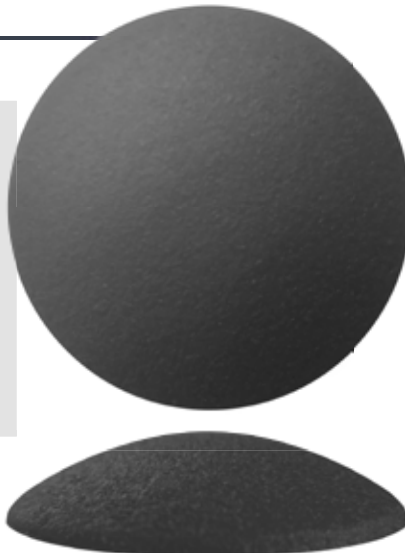



WARNINGPLATES



WARNING PLATES

TPUPK1

TPUP polyurethane

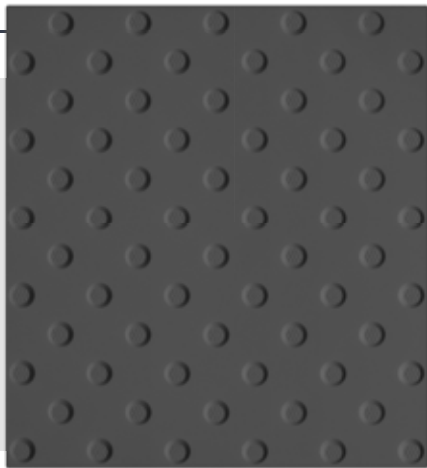

412,5x450mm

TPUPK2

TPUP polyurethane

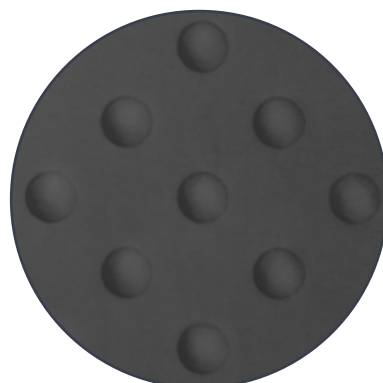

412,5x450mm

MODELS



No adhesive

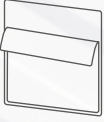

With adhesive



Metro Cash & Carry
Bratislava, Slovakia

TPUPK3

TPUP polyurethane

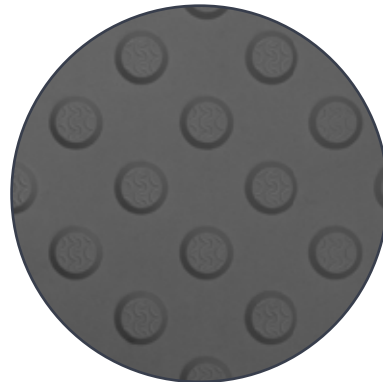
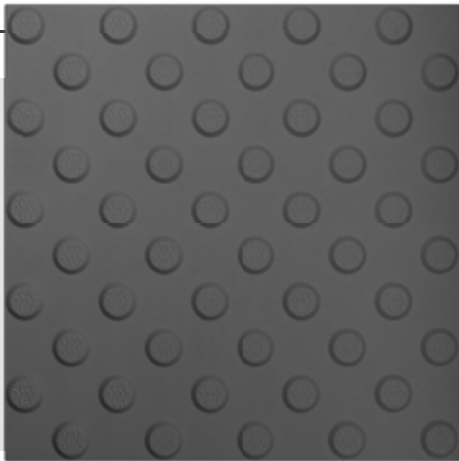

300x300mm

TPUPK4

TPUP polyurethane

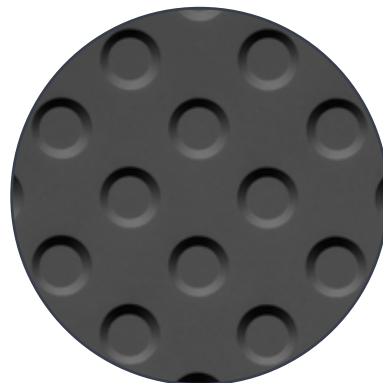
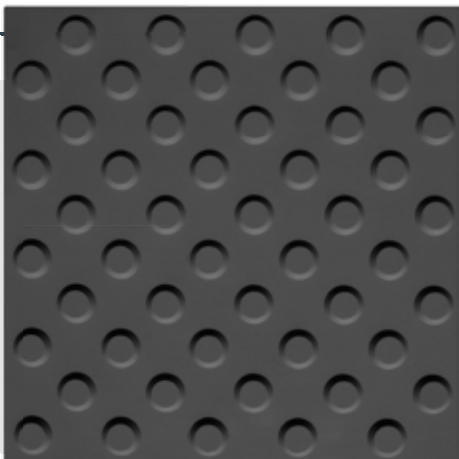

300x300mm

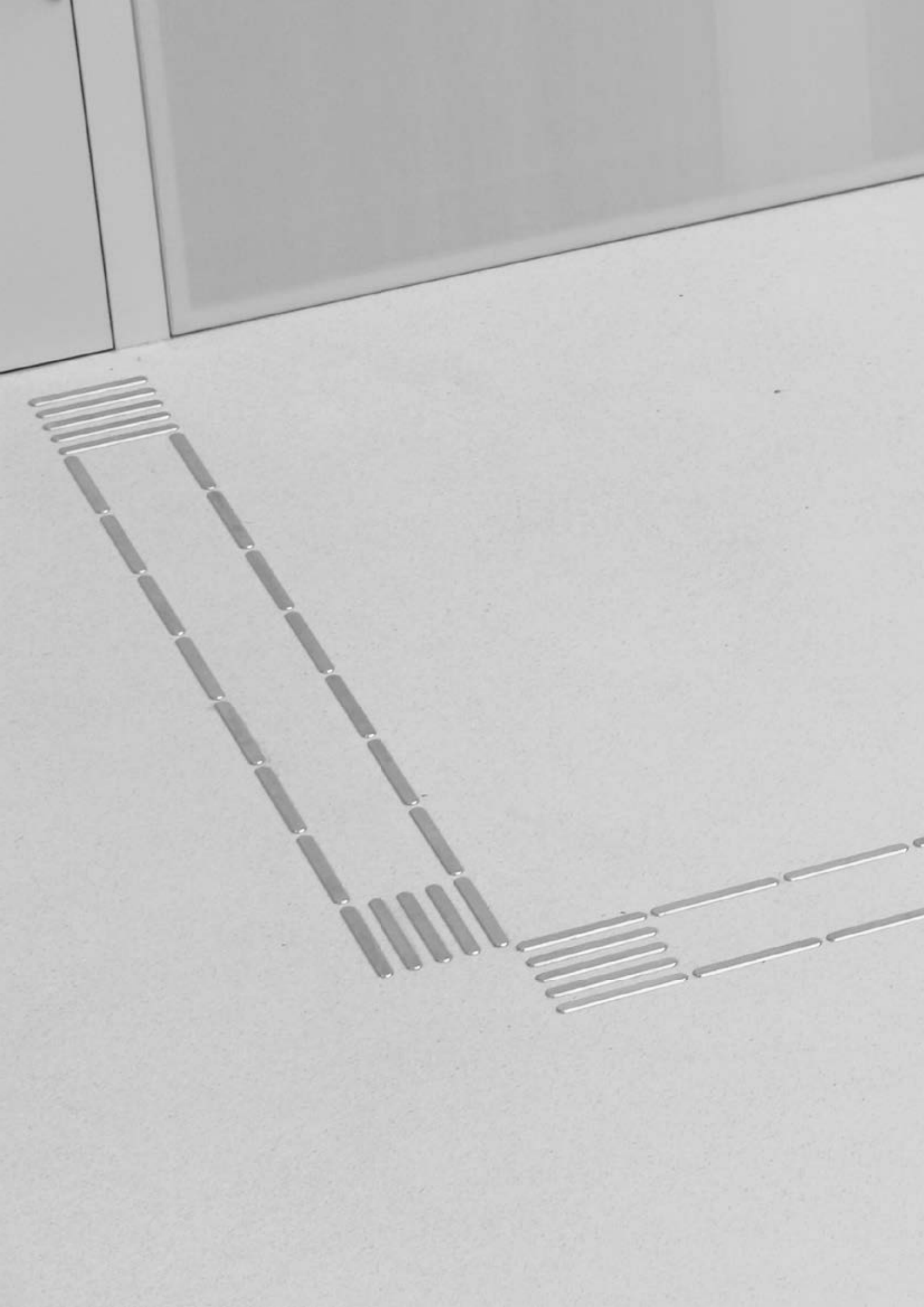

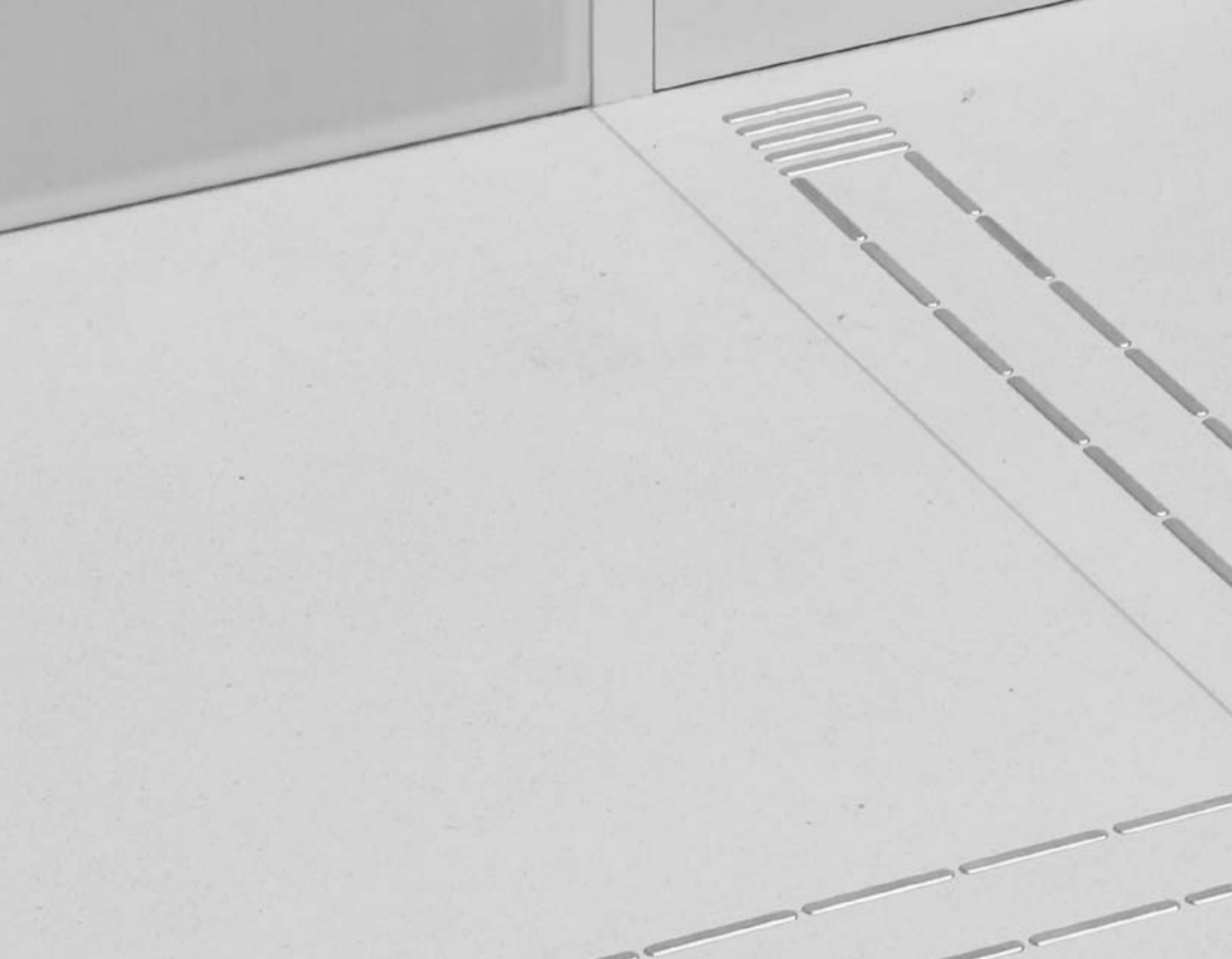

GUIDINGSTRIPS



GUIDING STRIPS

 LENGTH 140/280/300/400/500mm  WIDTH 17/20/25/30/35/40mm  HEIGHT 3/5/3,5/4/4,5mm

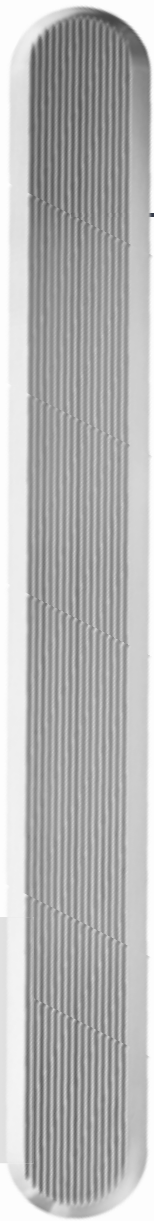

P1

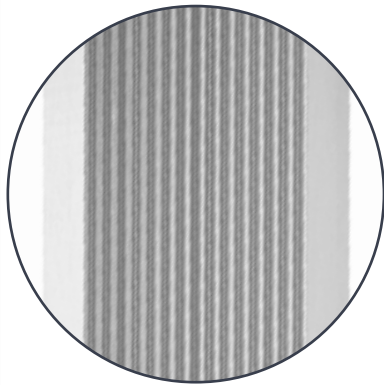

AISI stainless steel 316L/304

MS brass

BR bronze

AL aluminium

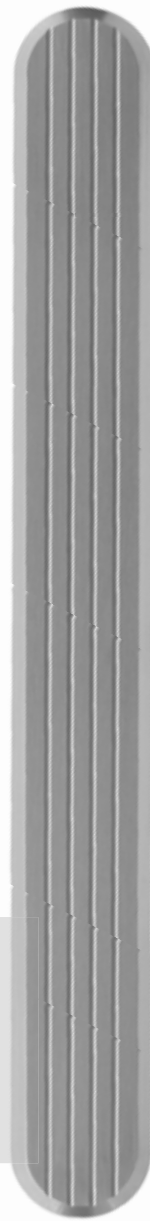
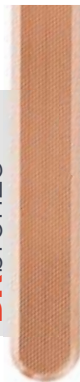

P2

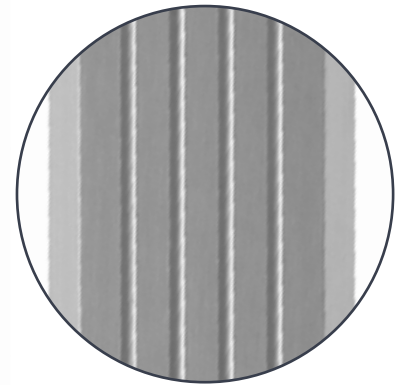

AISI stainless steel 316L/304

MS brass

BR bronze

AL aluminium

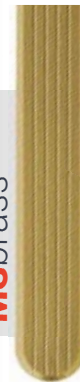

MODELS



With pin



No pin



Self-adhesive

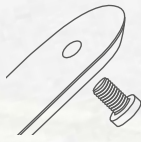

Screw opening

SURFACE TREATMENT

Standard

Polished

Black PVD

Gold PVD

Sandblasted



Poprad-Tatry railway station
Poprad-Tatry, Slovakia

PH

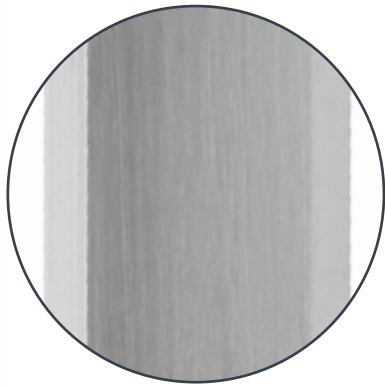

AISI stainless steel 316L/304

MS brass

BR bronze

AL aluminium

PHR

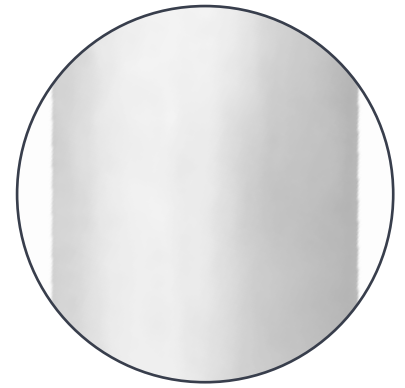

AISI stainless steel 316L/304

MS brass

BR bronze

AL aluminium



GUIDINGSTRIPS

 LENGTH 140/280/300/400/500mm  WIDTH 17/20/25/30/35/40mm  HEIGHT 3/5/3,5/4/4,5mm



PD1

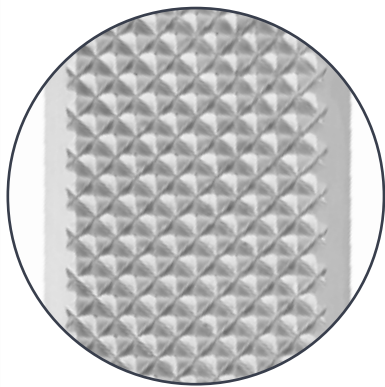

AISI stainless steel 316L/304

MS brass

BR bronze

AL aluminium

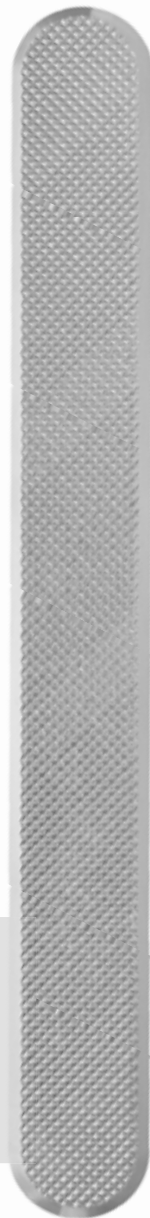

PD2

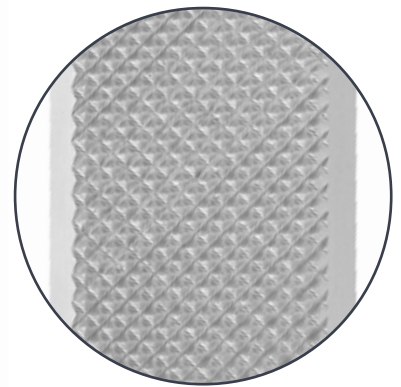

AISI stainless steel 316L/304

MS brass

BR bronze

AL aluminium

MODELS

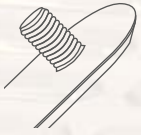

With pin



No pin



Self-adhesive

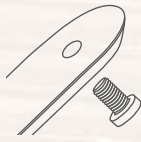

Screw opening

SURFACE TREATMENT

- Standard
- Polished
- Black PVD
- Gold PVD
- Sandblasted



Austrian Standards Meeting Center
Vienna, Austria

PD3

PD4

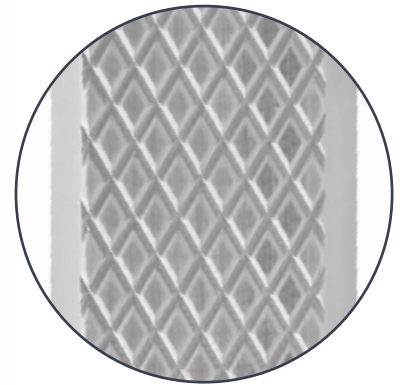
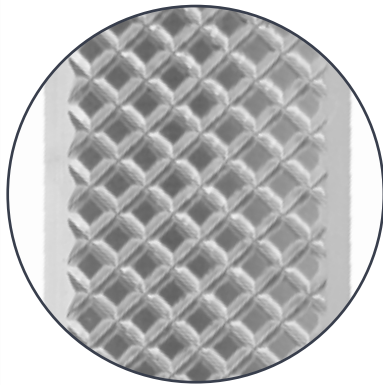

AISI stainless steel 316L/304

MS brass

BR bronze

AL aluminium

AISI stainless steel 316L/304

MS brass

BR bronze

AL aluminium



GUIDINGSTRIPS

 LENGTH 140/280/300/400/500mm  WIDTH 17/20/25/30/35/40mm  HEIGHT 3/5/3,5/4/4,5mm

PP

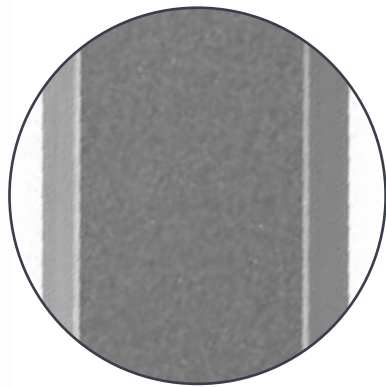

AISI stainless steel 316L/304

MS brass

BR bronze

AL aluminium

P TPU

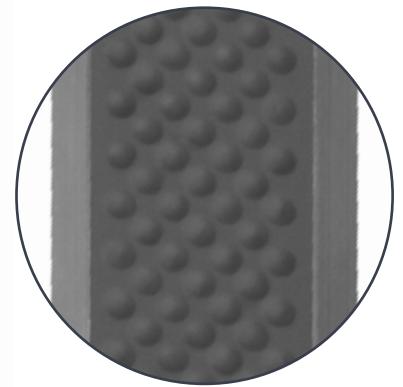

AISI stainless steel 316L/304

MS brass

BR bronze

AL aluminium

MODELS

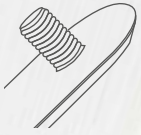

With pin



No pin



Self-adhesive

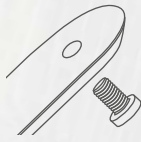

Screw opening

SURFACE TREATMENT

- Standard
- Polished
- Black PVD
- Gold PVD
- Sandblasted



harbour boardwalk Sørenga brygge
Oslo, Norway

P PVC

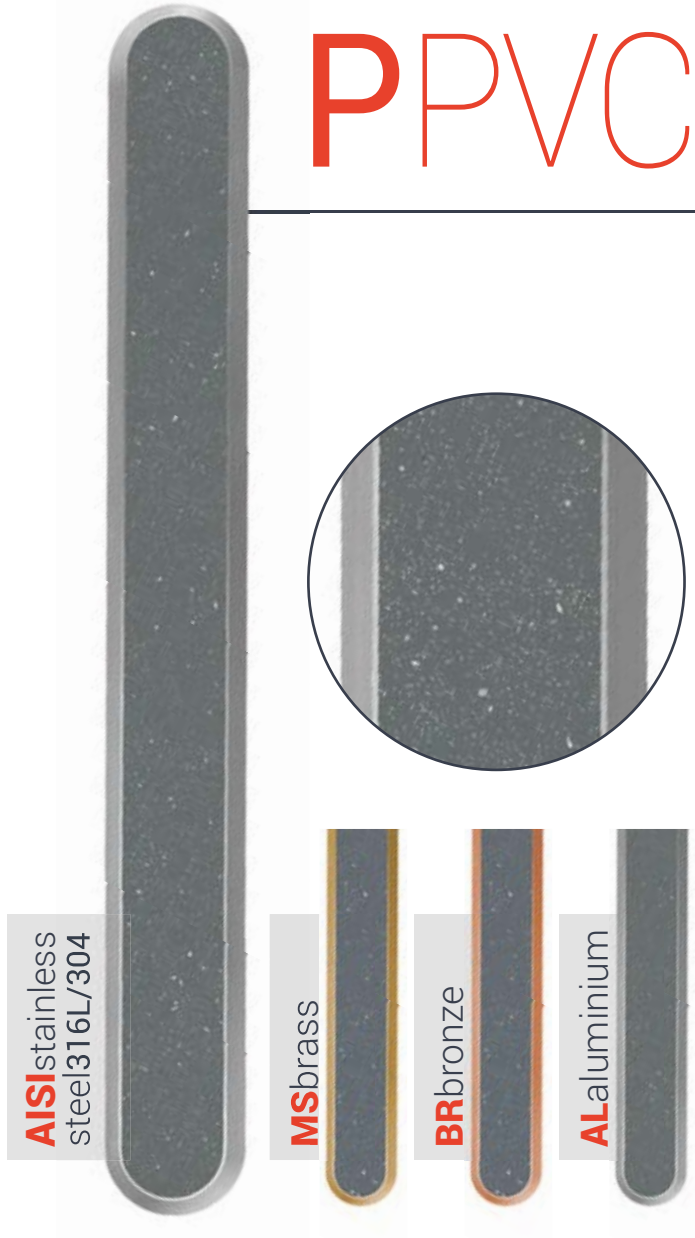

AISI stainless steel 316L/304

MSbrass

BRbronze

ALaluminium

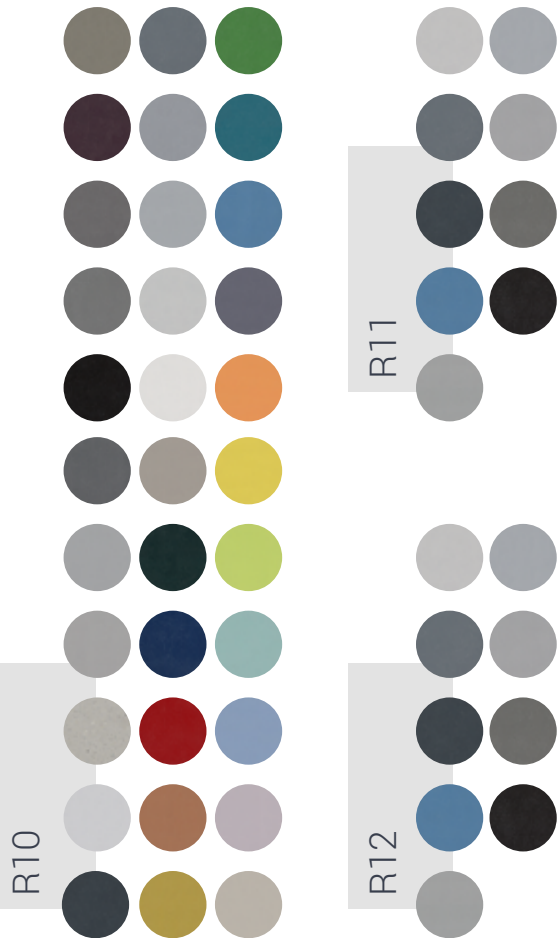

R10

R11

R12



GUIDINGSTRIPS

 LENGTH 140/280/300/400/500mm  WIDTH 17/20/25/30/35/40mm  HEIGHT 3/5/3,5/4/4,5mm

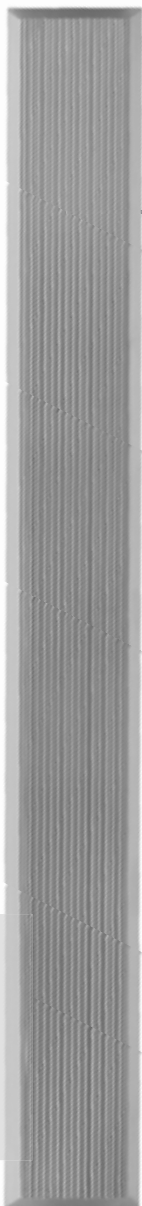

P1H

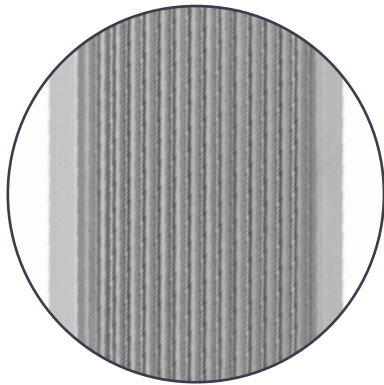

AISI stainless steel 316L/304

MS brass

BR bronze

AL aluminium

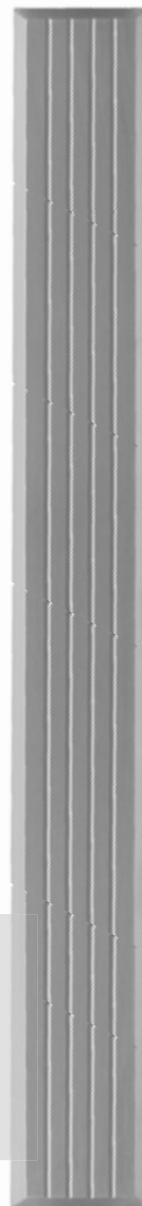

P2H

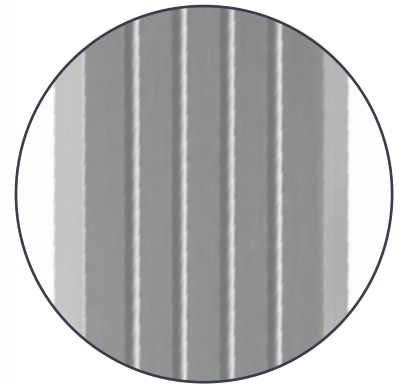

AISI stainless steel 316L/304

MS brass

BR bronze

AL aluminium



MODELS

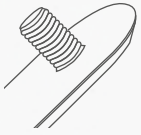

With pin



No pin



Self-adhesive

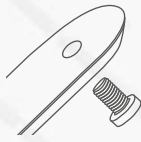

Screw opening

SURFACE TREATMENT

- Standard
- Polished
- Black PVD
- Gold PVD
- Sandblasted

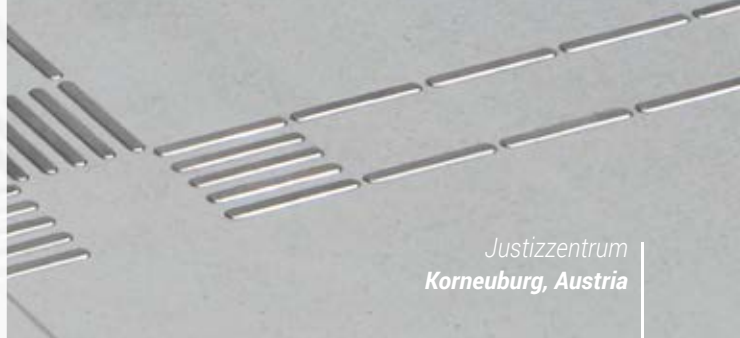

Justizzentrum
Korneuburg, Austria

PHH

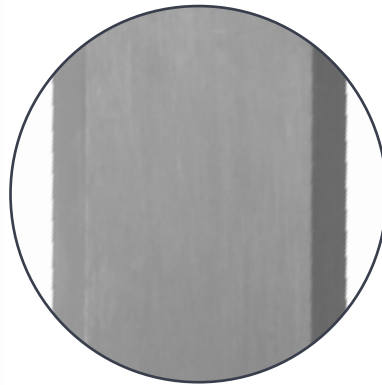

AISI stainless
steel 316L/304

MS brass

BR bronze

AL aluminium



GUIDING STRIPS

 LENGTH 140/280/300/400/500mm  WIDTH 17/20/25/30/35/40mm  HEIGHT 3/5/3,5/4/4,5mm

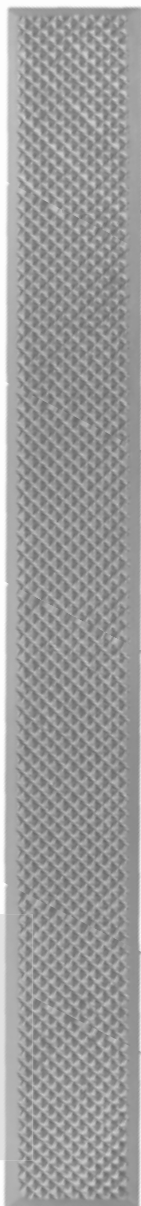

PD1H

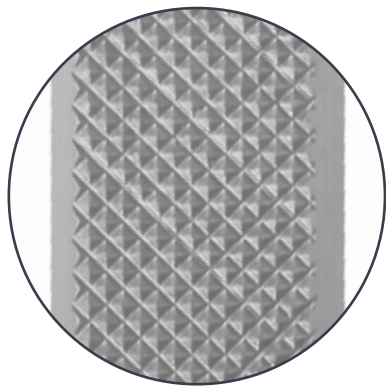

AISI stainless steel 316L/304

MS brass

BR bronze

AL aluminium

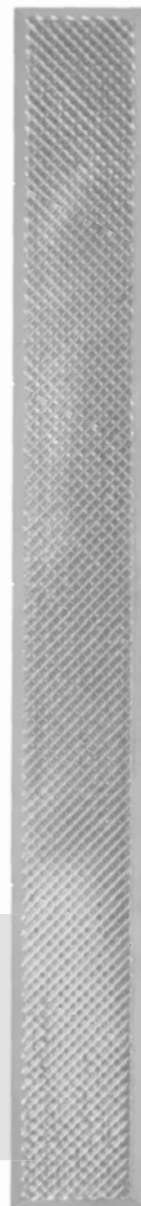

PD2H

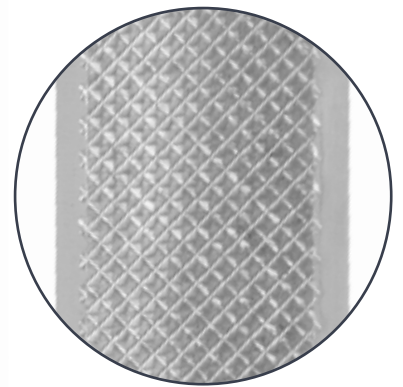

AISI stainless steel 316L/304

MS brass

BR bronze

AL aluminium

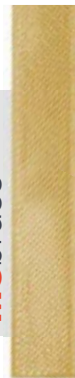

MODELS

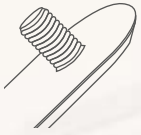

With pin



No pin

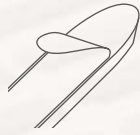

Self-adhesive

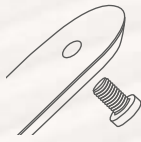

Screw opening

SURFACE TREATMENT

Standard

Polished

Black PVD

Gold PVD

Sandblasted



Justizzentrum
Korneuburg, Austria

PD3H

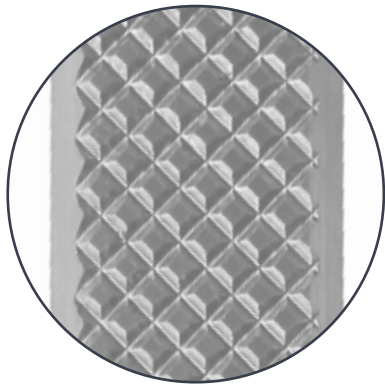

AISIstainless
steel316L/304

MSbrass

BRbronze

ALaluminium

PD4H

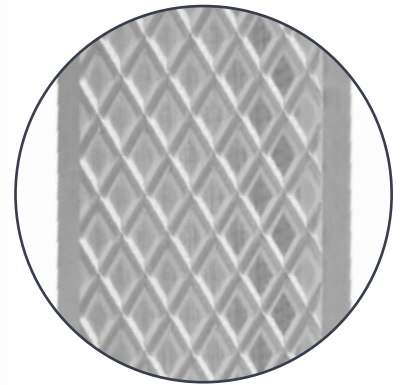

AISIstainless
steel316L/304

MSbrass

BRbronze

ALaluminium



GUIDING STRIPS

 LENGTH 140/280/300/400/500mm  WIDTH 17/20/25/30/35/40mm  HEIGHT 3/5/3,5/4/4,5mm

PPH

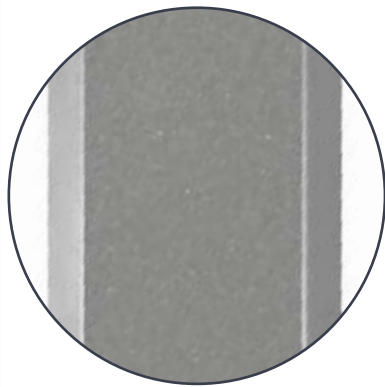

AISI stainless steel 316L/304

MS brass

BR bronze

AL aluminium

P TPUH

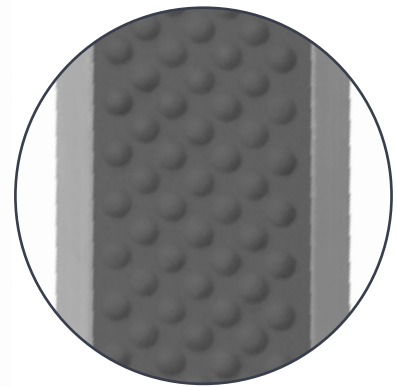
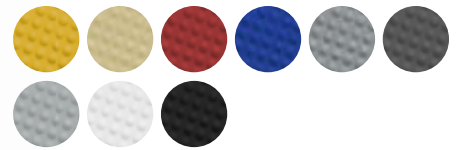

MS brass

BR bronze

AL aluminium

MODELS

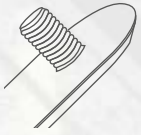

With pin



No pin



Self-adhesive

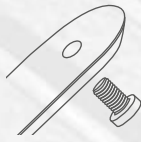

Screw opening

SURFACE TREATMENT

- Standard
- Polished
- Black PVD
- Gold PVD
- Sandblasted



Central Park
Bratislava, Slovakia

P PVCH

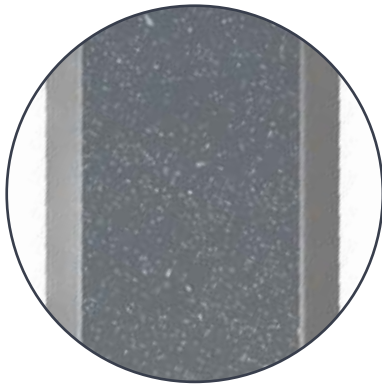

AISI stainless steel 316L/304

MS brass

BR bronze

AL aluminium

R10



R11



R12





GUIDINGSTRIPS

 LENGTH 140/200/270/280/
/295/300/500mm

 WIDTH 16/20/25/27/30/32/35mm

 HEIGHT 2,2/3/3,3/3,5/4/5

TPUP1

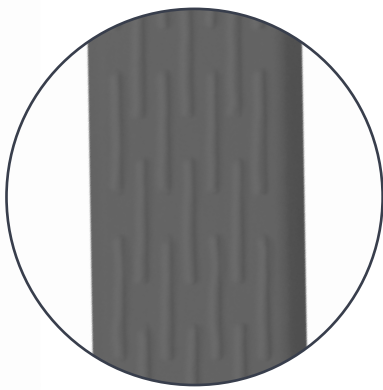

TPUpolyurethane

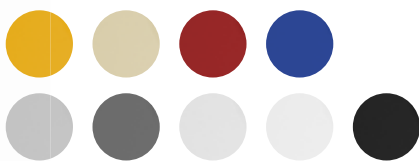

TPUP2



TPUpolyurethane

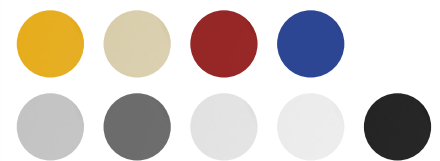

MODELS



With pin



No pin



Self-adhesive



Kasárne Kulturpark
Košice, Slovakia

TPUP3



TPU polyurethane

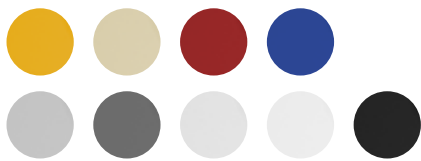
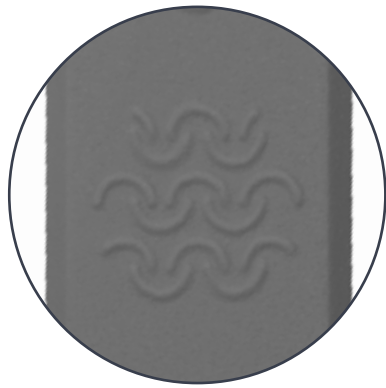

TPUP4

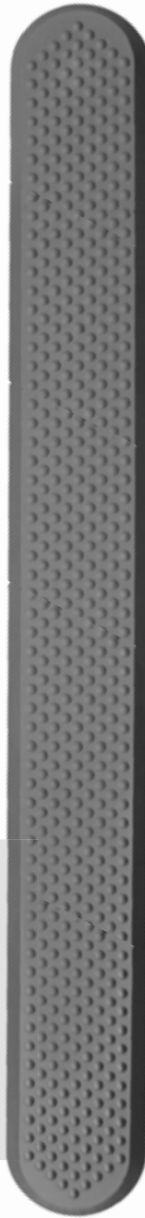

TPU polyurethane

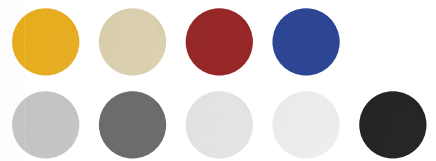
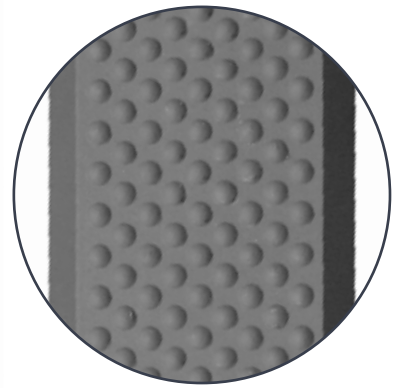



MODELS



With pin



No pin



Self-adhesive

 LENGTH 140/200/270/280/
/295/300/500mm

 WIDTH 16/20/25/27/30/32/35mm

 HEIGHT 2,2/3/3,3/3,5/4/5

TPU polyurethane

TPUPH

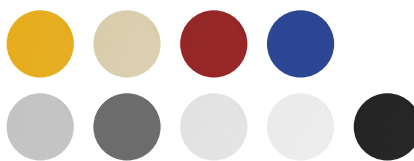
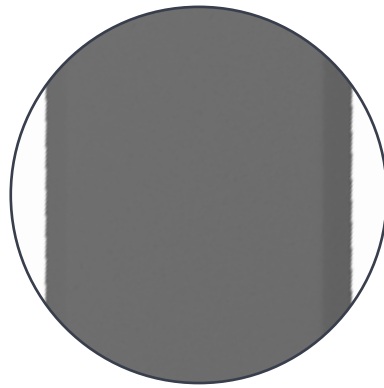



GUIDINGPLATES



GUIDING PLATES

TPUP P1

TPUP polyurethane

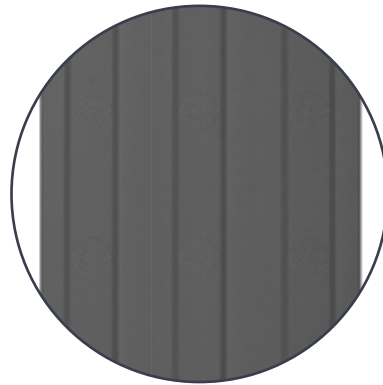

150X450mm

TPUP P2

TPUP polyurethane

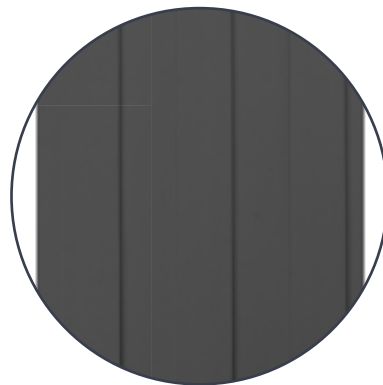

150X450mm

MODELS



No adhesive

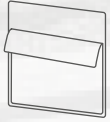

With adhesive



Schwechat railway station
Schwechat, Austria

TPUP P3

TPUP polyurethane

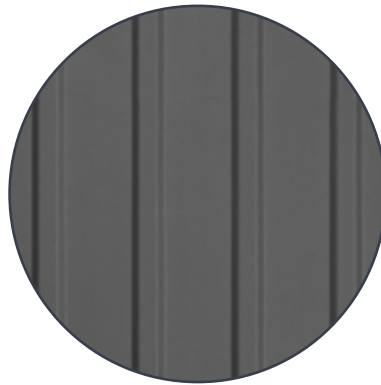
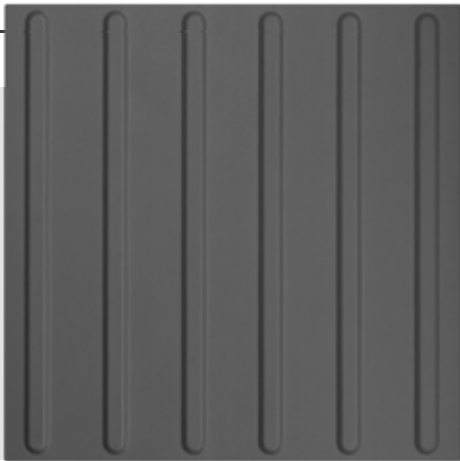

300x300mm

TPUP P4

TPUP polyurethane

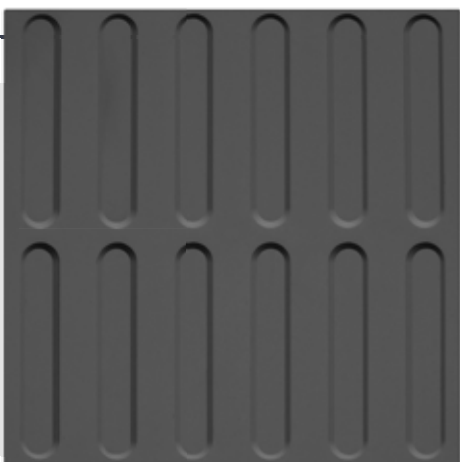

300x300mm



SIGNALPLATES

MODELS



No adhesive

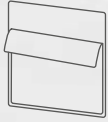

With adhesive



Kasárne Kulturpark
Košice, Slovakia

TPUP P3

TPUP polyurethane

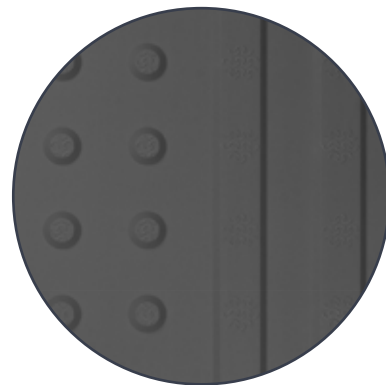
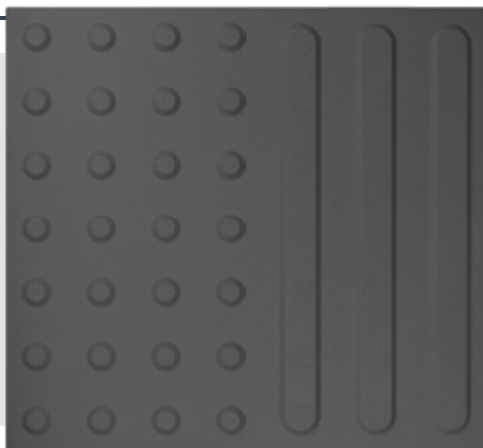

 385x415mm

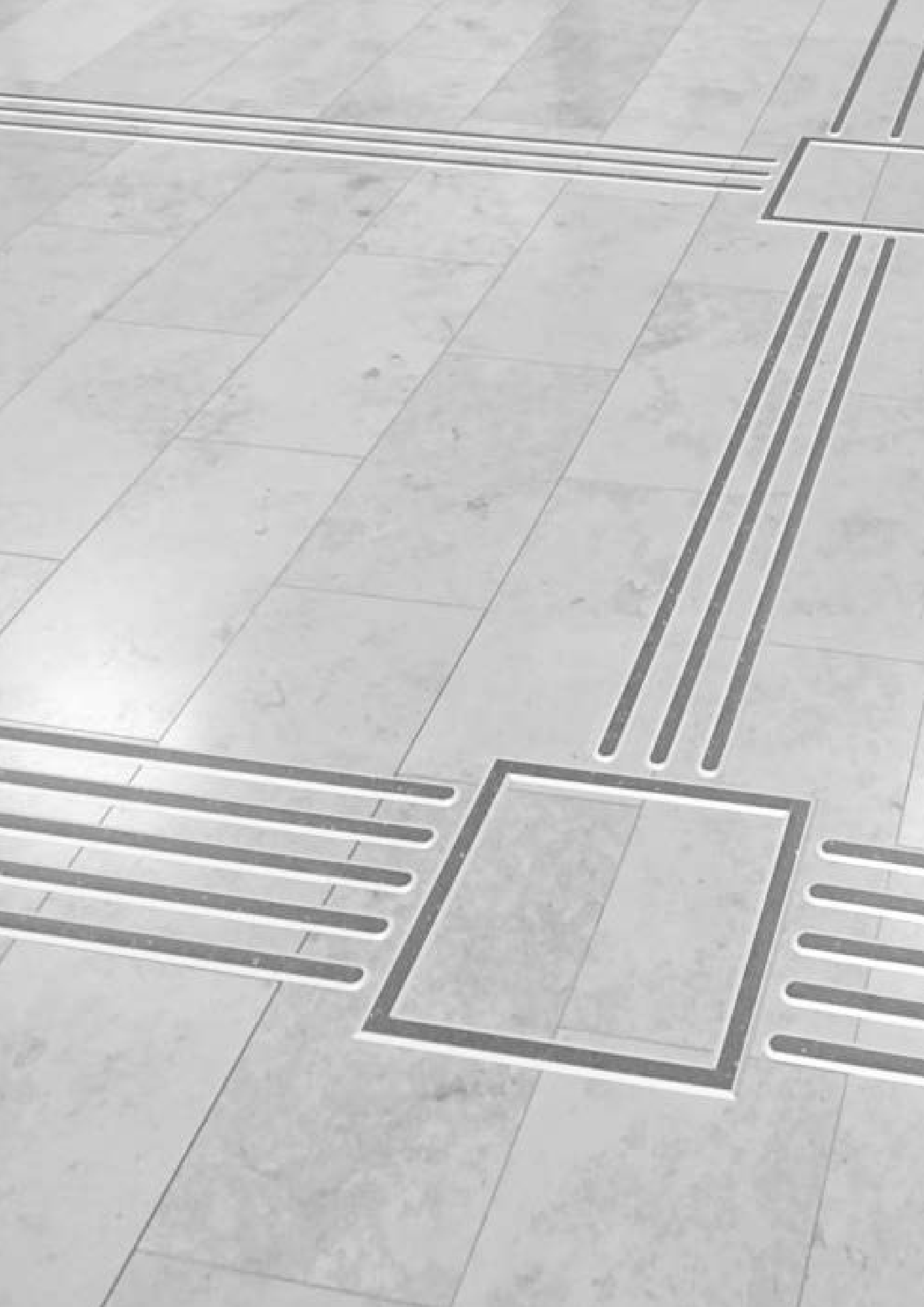



GUIDING LINES



GUIDING LINES

 LENGTH 200-6000mm

 WIDTH 35mm

 HEIGHT 3,5mm

ALV aluminium

C0PVC

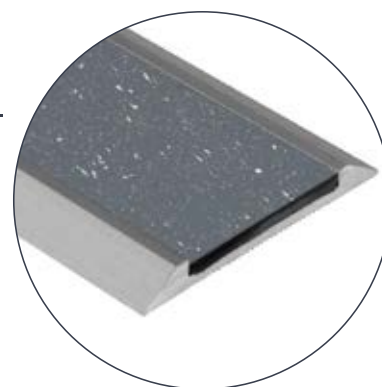

ALV aluminium

C31PVC

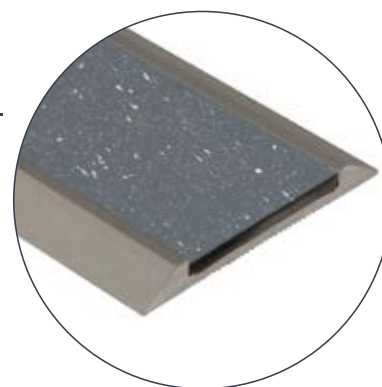

MODELS



No pin

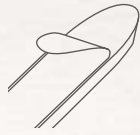

Self-adhesive

SURFACE TREATMENT

no elox

C0

C31

C32

C33

C34

C35



Technical university
Vienna, Austria

ALV aluminium

C32PVC

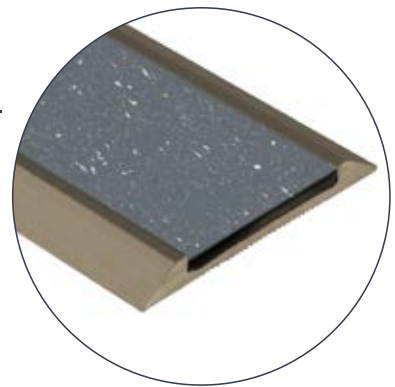

ALV aluminium

C33PVC

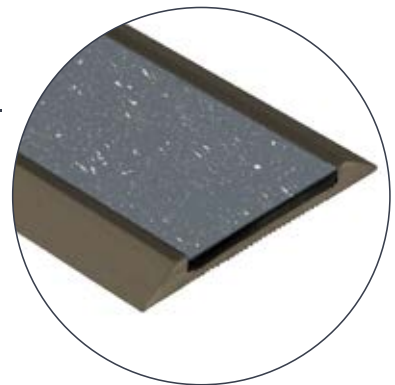

GUIDING LINES

 LENGTH 200-6000mm

 WIDTH 35mm

 HEIGHT 3,5mm

ALV aluminium



C34 PVC

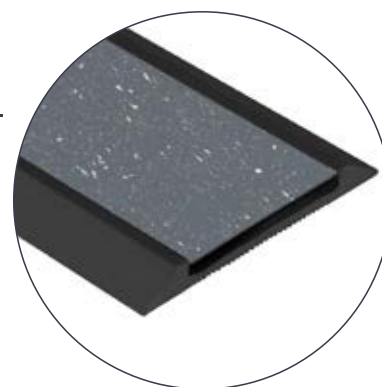

ALV aluminium



C35 PVC

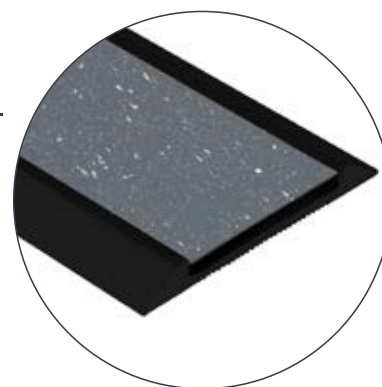

MODELS



No pin



Self-adhesive

SURFACE TREATMENT

no elox

C0

C31

C32

C33

C34

C35

HTL Voralberg
Feldkirch, Austria

ALUMINIUM ELOXATION COLOURS



PVC INSERT COLOURS

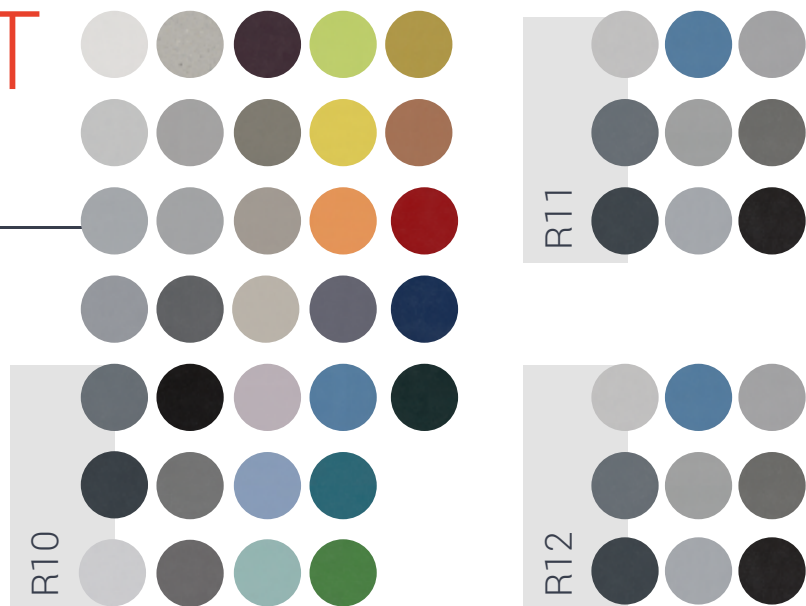

TECHNICAL SPECIFICATIONS



WARNINGSTUDS

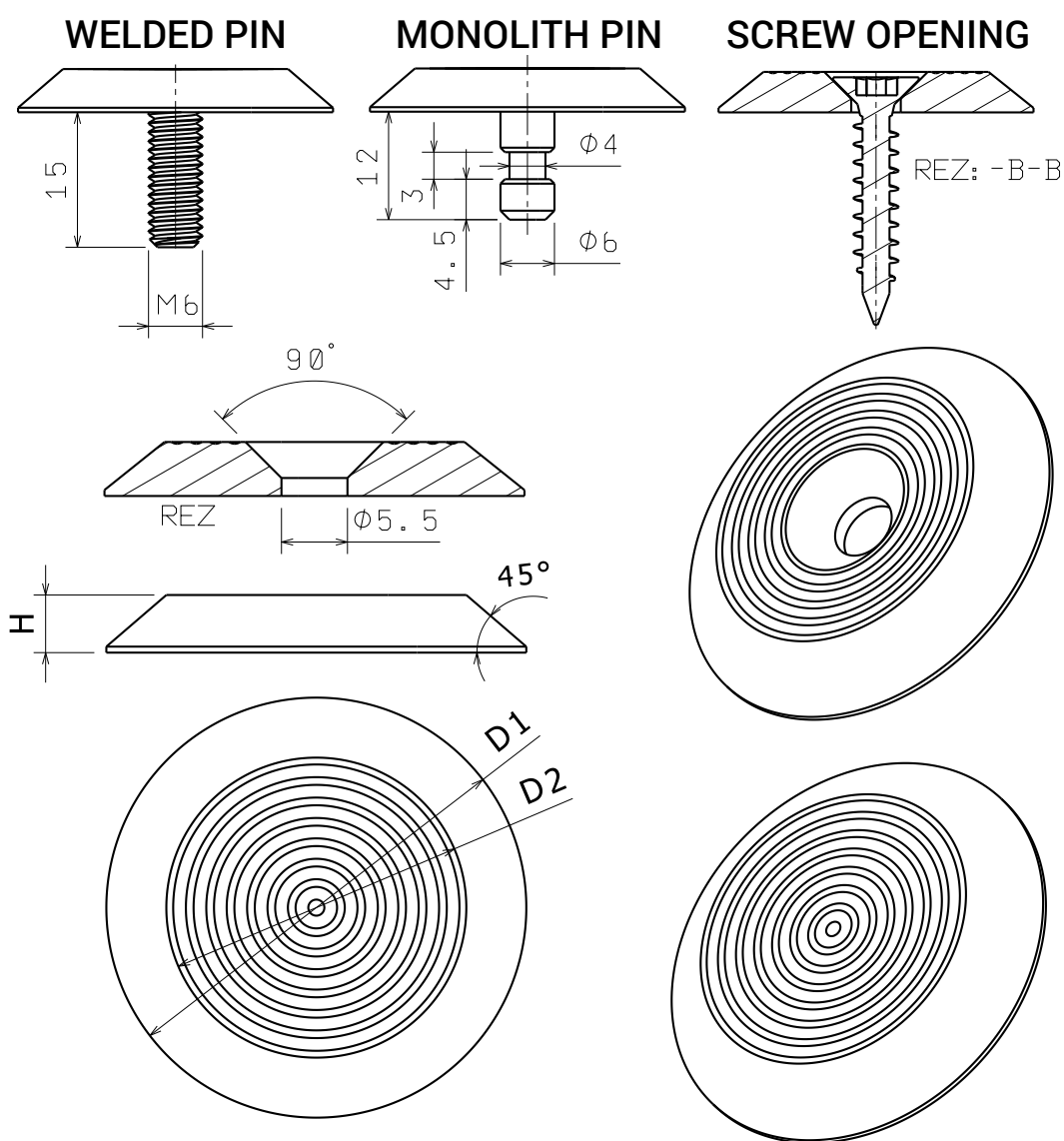

D1	D2					
	H-1,5	H-3	H-3,5	H-4	H-4,5	H-5
15	12	9	8	7	6	5
25	22	19	18	17	16	15
30	27	24	23	22	21	20
35	32	29	28	27	26	25
50	47	44	43	42	41	40

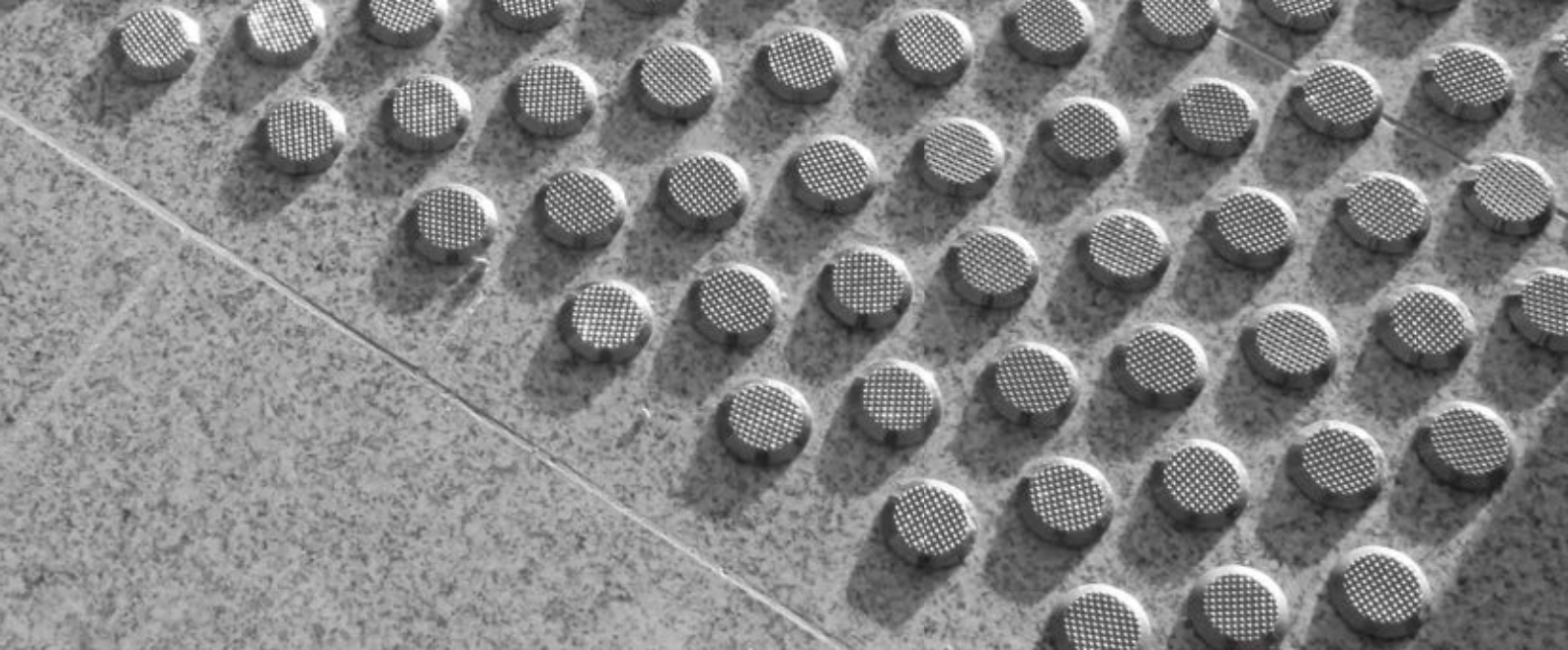

WELDED PIN



MONOLITH PIN



TPU PIN



WARNING STUDS IN PARALLEL ARRANGEMENT, VERTICAL AND ISOMETRIC VIEW

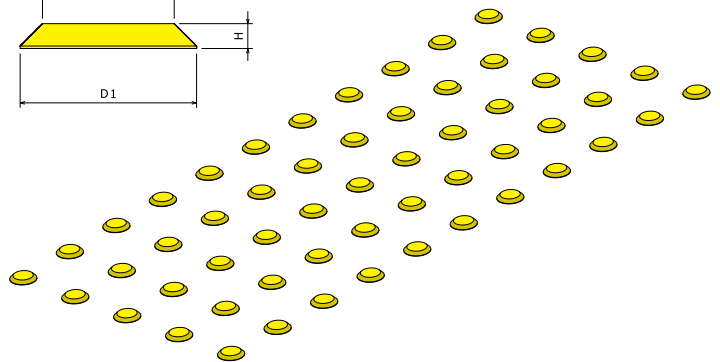
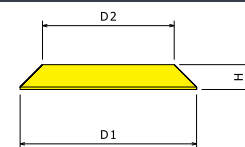
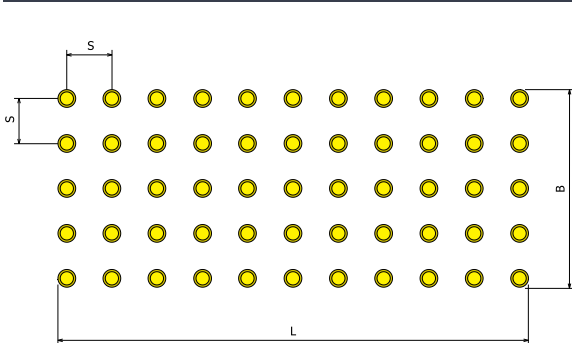

WARNING STUDS IN DIAGONAL ARRANGEMENT, VERTICAL AND ISOMETRIC VIEW

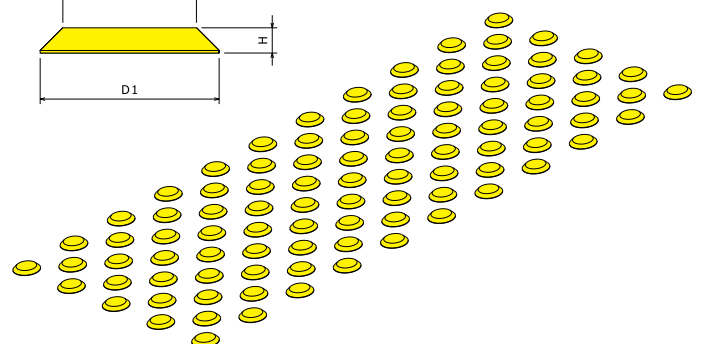
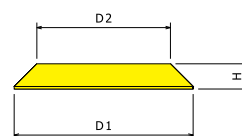
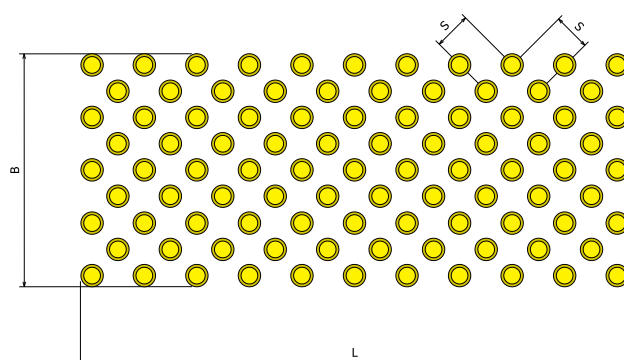

TECHNICAL SPECIFICATIONS



GUIDING STRIPS

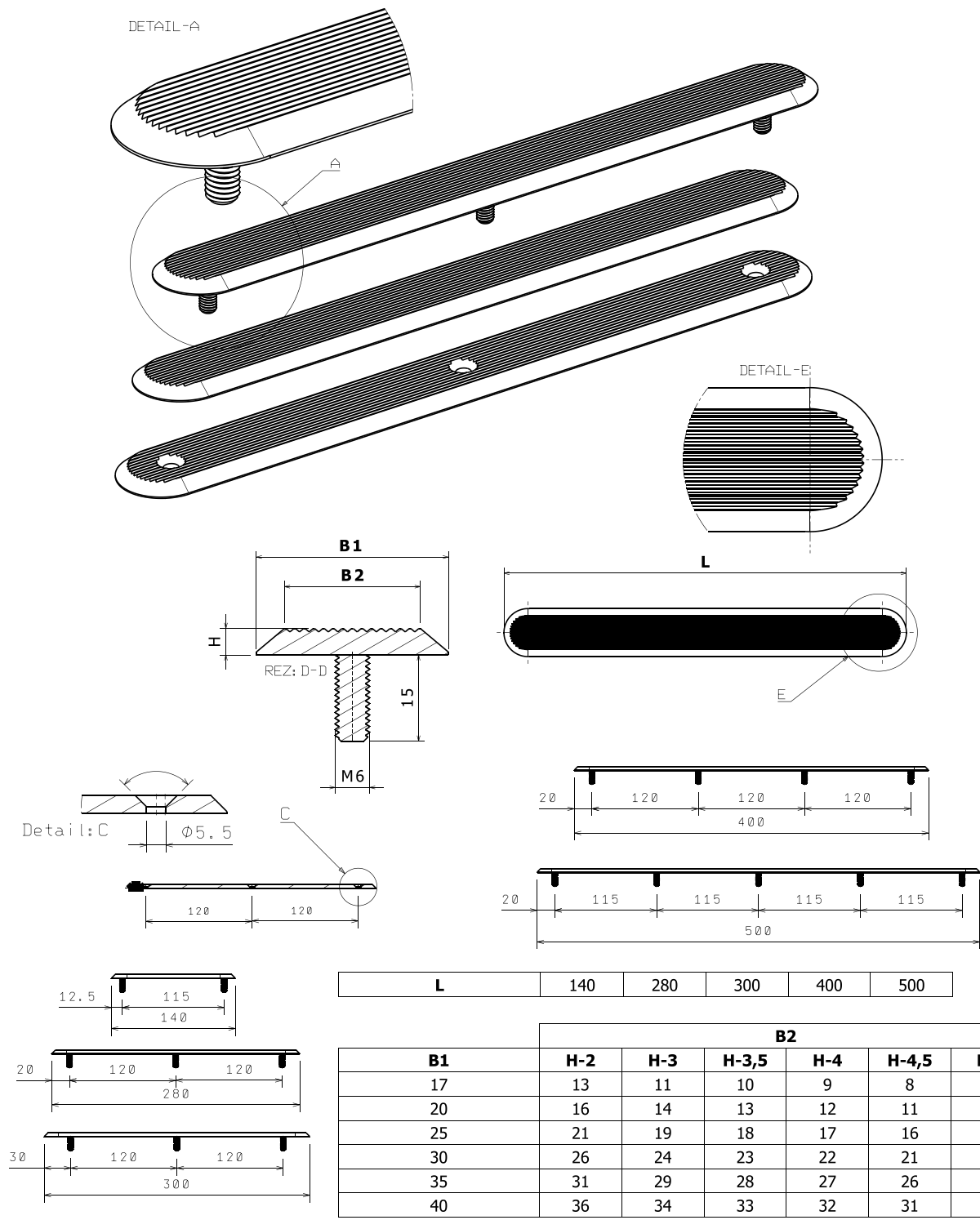

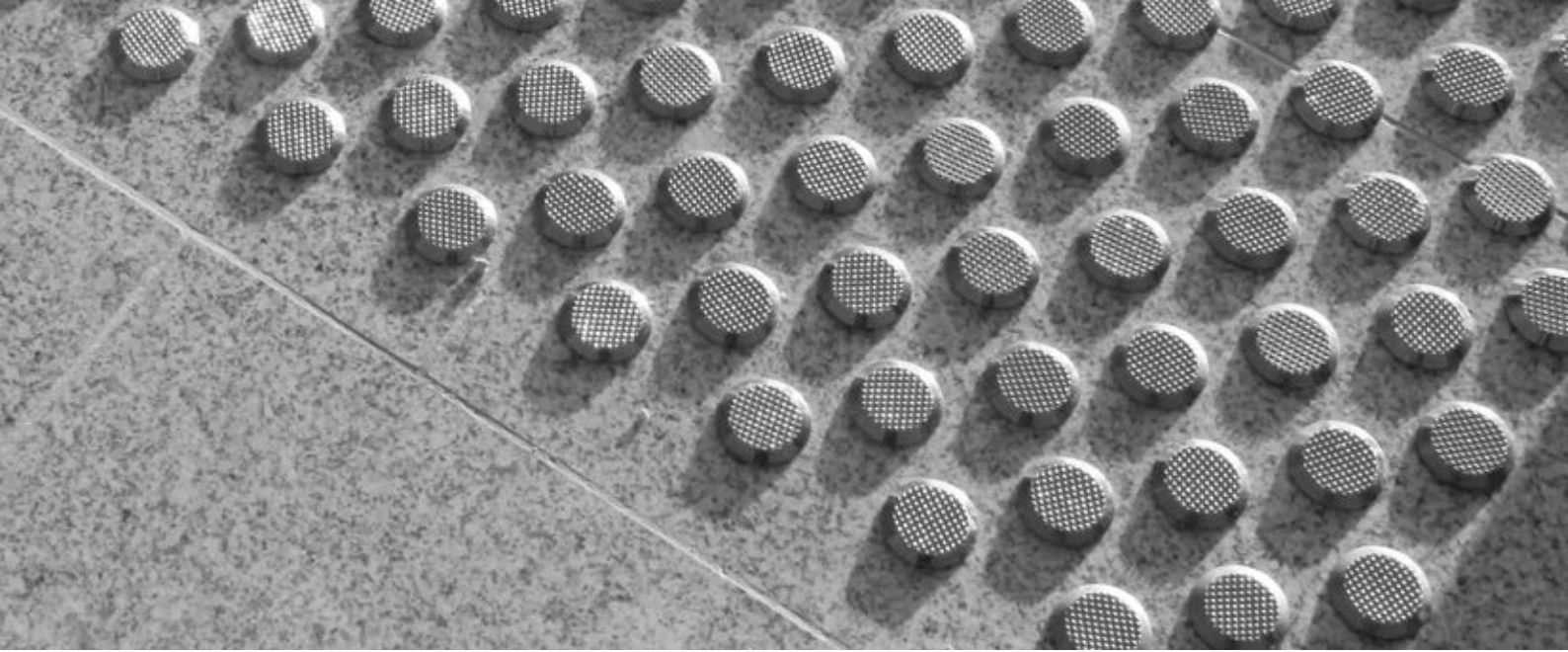

GUIDING STRIPS ARRANGEMENT

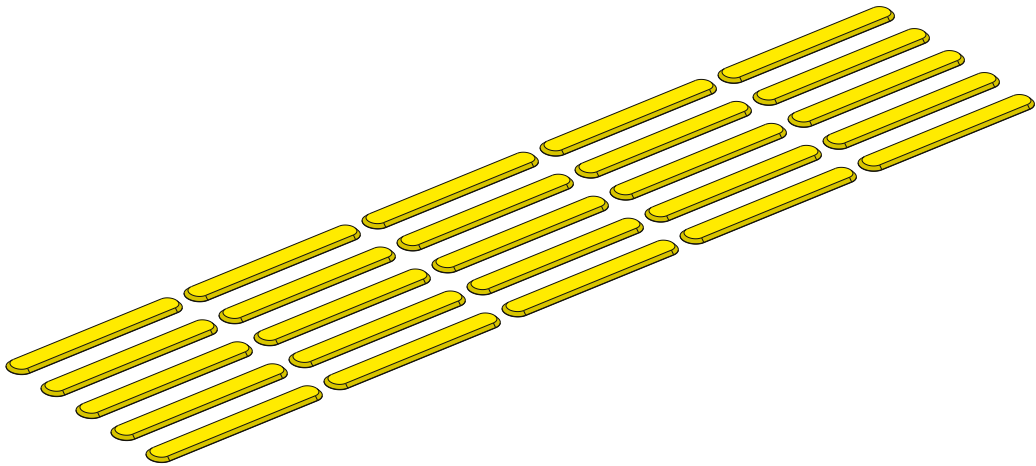
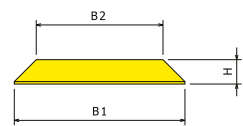
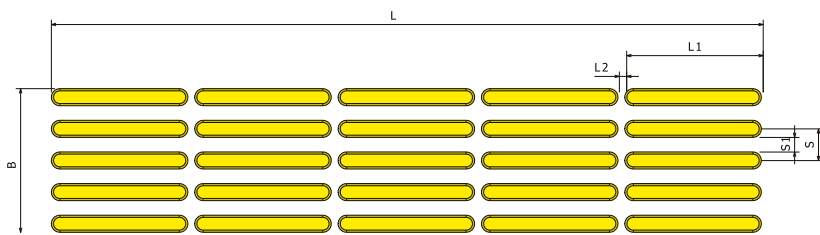

ILLUMINANCE CONTRAST



WARNING STUDS

AISILINE



MSLINE

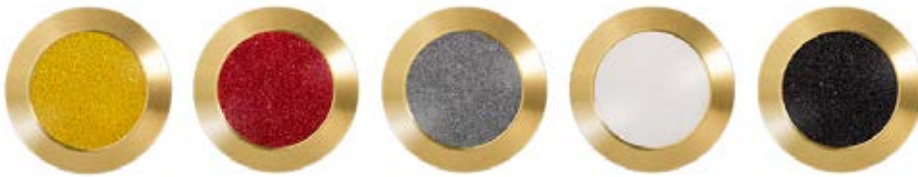

BRLINE



ALLINE



TPULINE





GUIDINGSTRIPS

AISILINE

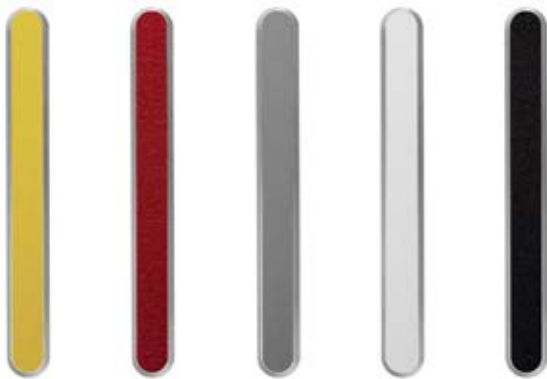

MSLINE



BRLINE



ALLINE



TPULINE





Bioclean doo
062669976
office@bioclean.rs
www.bioclean.rs